

wBolt

Cerrojo inteligente

Manual de Instalación

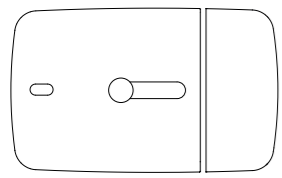

CONTENIDO DE LA CAJA

- ✓ wBolt
- ✓ Soporte base
- ✓ Recibidor
- ✓ Espaciadores
- ✓ Pieza de Instalación
- ✓ Tornillos 01 (x2)
- ✓ Tornillos 02 (x6)
- ✓ Tornillos 03 (x2)
- ✓ Pilas AA (x4)

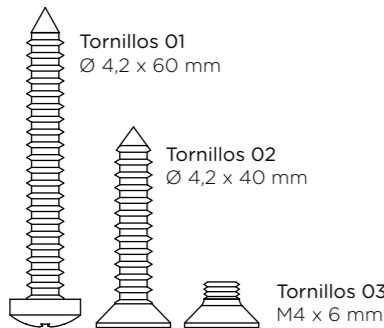

HERRAMIENTAS NECESARIAS

- Taladro eléctrico
- Broca para madera de diámetro 2,5 mm
- Marcador permanente
- Destornillador con punta de estrella (PH2)
- Cinta métrica
- Nivelador

2 Retire el soporte base y taladre en las cuatro marcas.

* Si el grosor de su puerta mide menos de 40mm, debe comprar unos tornillos más cortos antes de taladrar.

3 Atornille el soporte base con los tornillos 02.

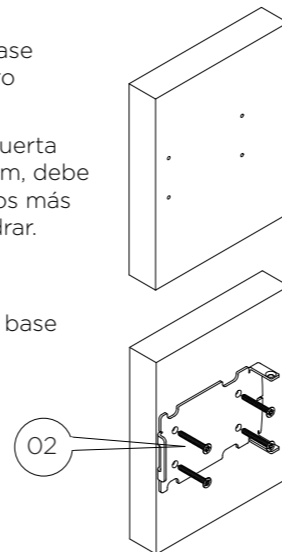

6 Una vez encajado, atornille las dos piezas en las patillas laterales con los tornillos 03.

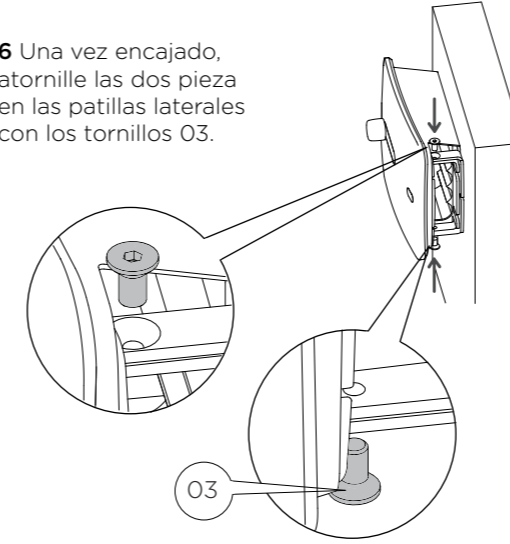

8 Introduzca la Pieza de Instalación en el recibidor.

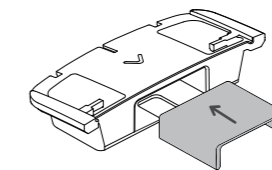

9 Encaje el recibidor con el wBolt.

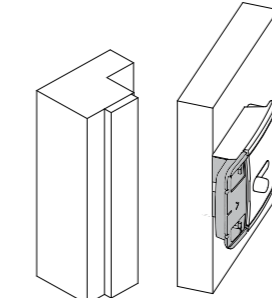

11 Marque los dos agujeros en el marco de la puerta.

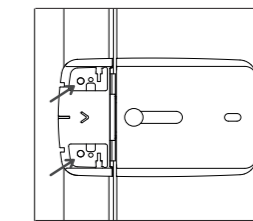

* Si ha decidido cambiar el soporte base del recibidor, marque también los dos agujeros en el lateral del marco de la puerta.

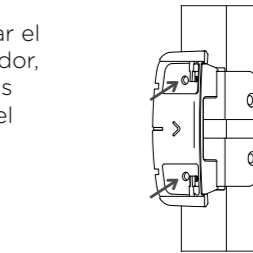

14 Ponga la tapa del recibidor empujando hacia dentro.

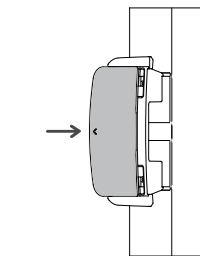

15 Cierre la puerta. Introduzca las pilas y ponga la tapa en el wBolt.

* Fíjese en las marcas +/- de la tapa para poner las pilas correctamente.

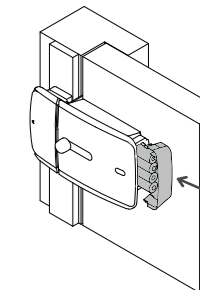

INSTRUCCIONES DE USO

- ✓ Lea atentamente las instrucciones.
- ✓ Descárguese la App y regístrese como usuario.
- ✓ Antes de instalar el wBolt, compruebe que funciona correctamente escaneando el código QR del producto.
- ✓ Asegúrese de que las medidas del wBolt encajan con su puerta.

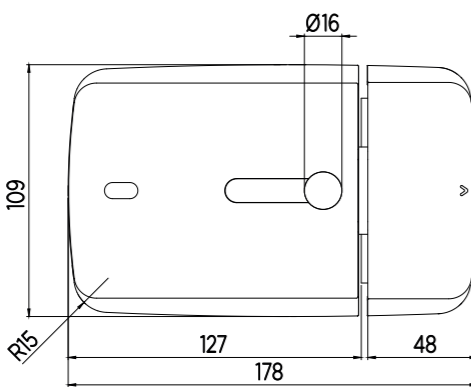

PASOS A SEGUIR

1 Elija el lugar donde quiere instalar el wBolt. Coloque el soporte base a la altura deseada y enráselo al borde de la puerta. Asegúrese que está recto usando el nivelador y marque los cuatro agujeros con el marcador.

* Tenga cuidado que el lugar elegido no coincida con los puntos de seguridad de la puerta.

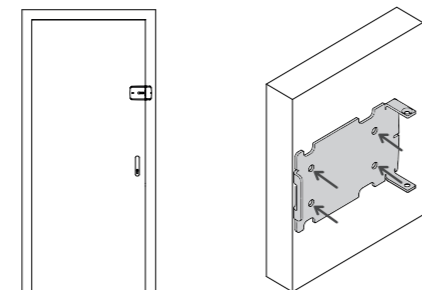

4 Con la cinta métrica mida la distancia que hay desde la ranura del soporte base hasta el suelo y apúntelo (cuando registre el producto en la APP lo va a necesitar).

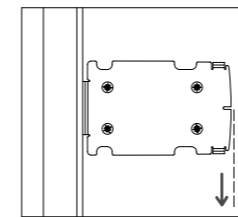

5 Encaje el wBolt en el soporte base.

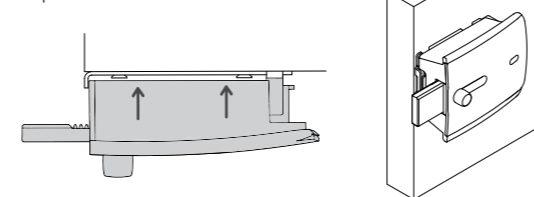

7 Saque la tapa del recibidor empujando hacia fuera.

Atención:

Si desea más seguridad, antes de instalar el recibidor en la puerta, puede cambiar el soporte base instalado en el recibidor (1) por el otro soporte base (2), quitando los dos tornillos.

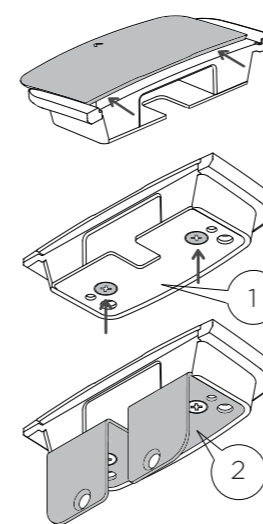

10 Con la puerta cerrada, observe la distancia que hay entre el marco de la puerta y el recibidor. Esta diferencia de altura se debe suplementar con los espaciadores necesarios para que el recibidor y el wBolt encajen correctamente.

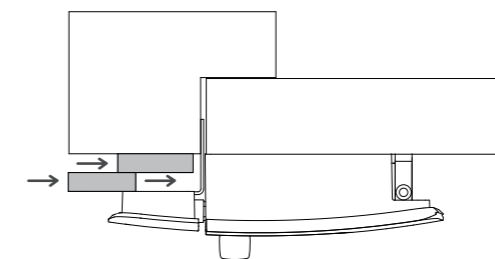

12 Abra la puerta. Retire el recibidor y la Pieza de Instalación.

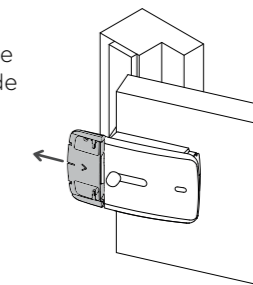

13 Taladre las dos (o cuatro) marcas. Vuelva a encajar el recibidor y atornille con los tornillos 01 y 02.

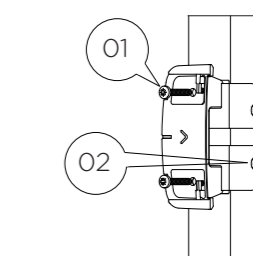

16 Una vez instalado el producto, escanee el código QR y siga los pasos que le indica la APP.

RECOMENDACIONES

- ✓ Antes de salir de casa, compruebe que el cerrojo funciona correctamente.
- ✓ Si no se completa una apertura o un cierre, contacte con el servicio técnico de Watchman Door.
- ✓ En la APP podrá ir consultando el estado de la batería del wBolt.

wBolt

Intelligent bolt

Installation Manual

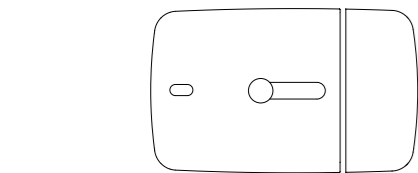

BOX CONTENTS

- ✓ wBolt
- ✓ Bracket base
- ✓ Receiver
- ✓ Spacers
- ✓ Installation part
- ✓ Screws 01 (x2)
- ✓ Screws 02 (x6)
- ✓ Screws 03 (x2)
- ✓ AA batteries (x4)

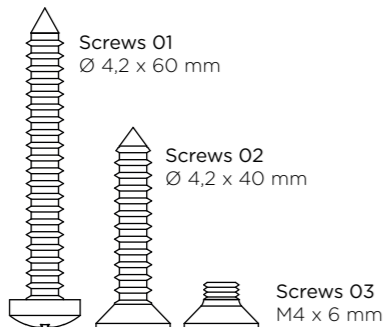

TOOLS REQUIRED

- Electric drill
- 2,5 mm diameter wood drill bit
- Permanent marker
- Phillips head screwdriver (PH2)
- Measuring tape
- Spirit level

2 Remove the bracket base and drill in the four marks.

* If your door thickness is less than 40mm, you should buy shorter screws before drilling.

3 Screw the bracket base with screws 02.

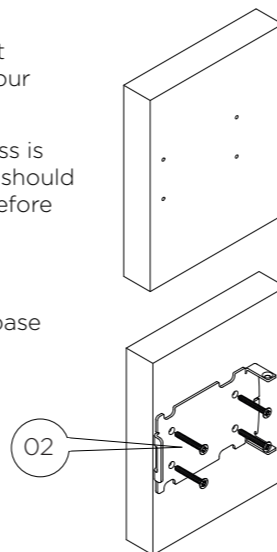

6 Once fitted, secure the two pieces with screws 03.

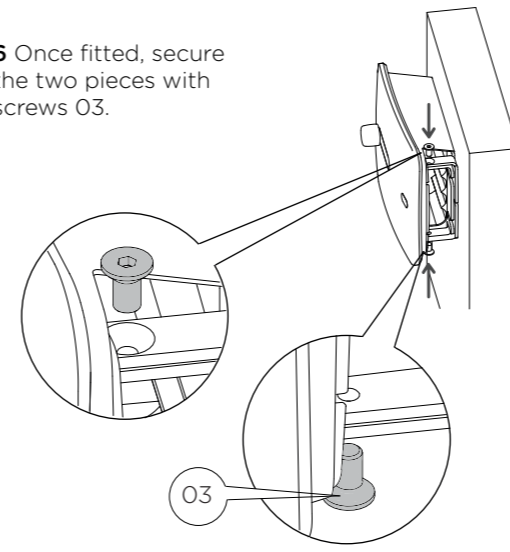

8 Insert the Installation part into the receiver.

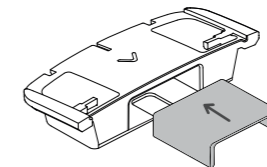

9 Fit the receiver with wBolt.

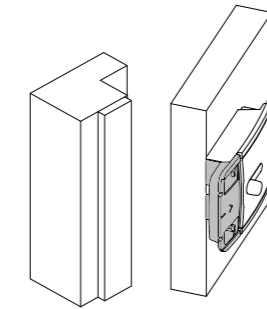

11 Mark the two holes in the door frame.

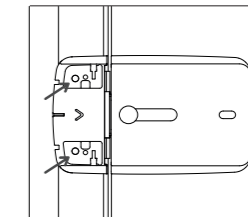

* If you have decided to change the base of the receiver, also mark the two holes in the side of the door frame.

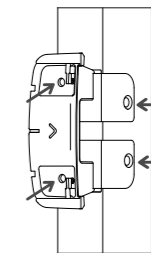

14 Replace the receiver cover by pushing inward.

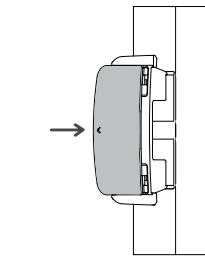

15 Close the door. Insert the batteries and put the cover on the wBolt.

* Look at the marks +/- in the cover to correctly insert the batteries.

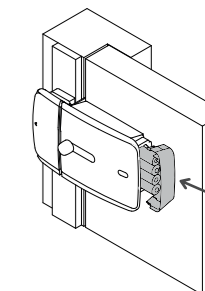

INSTRUCTIONS FOR USE

- ✓ Read the instructions carefully.
- ✓ Download the App and register as a user.
- ✓ Before installing the wBolt, check that it works correctly by scanning the product's QR code.
- ✓ Make sure the measurements of the wBolt fit your door.

DOWNLOAD THE APP

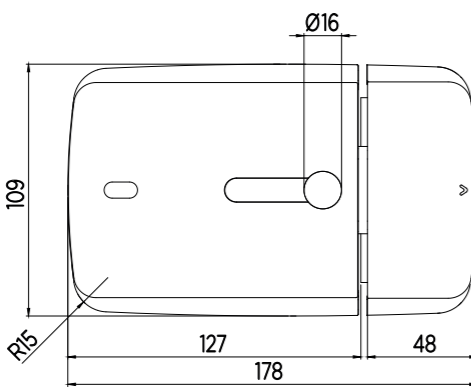

INSTALLATION STEPS

1 Choose the place where you want to install the wBolt. Position the bracket base at the desired height and place it at the edge of the door. Make sure it is straight using the spirit level and mark the four holes with the marker.

* Take care that the chosen place doesn't coincide with the security points of the door.

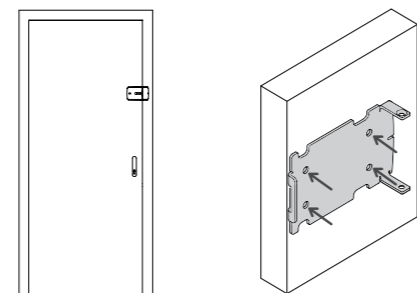

4 With the tape measure, measure the distance from the groove of the bracket base to the ground and write it down (when you register the product in the APP you will need it).

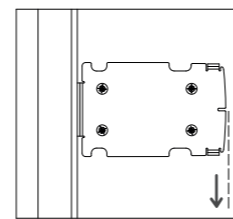

5 Fit the wBolt into the bracket base.

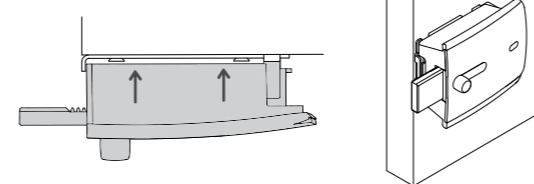

7 Remove the receiver cover by pushing it out.

Attention:

If you want more security, before installing the receiver on the door, you can change the base support installed on the receiver (1) for the other base support (2), removing the two screws.

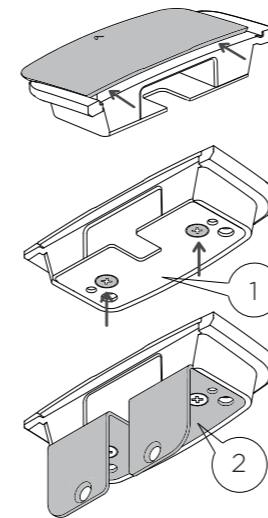

10 With the door closed, observe the distance between the door frame and the receiver. This difference in height must be supplemented with the spacers necessary for the receiver and the wBolt to fit correctly.

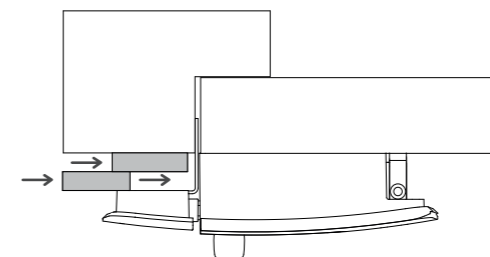

12 Open the door. Remove the receiver and Installation part.

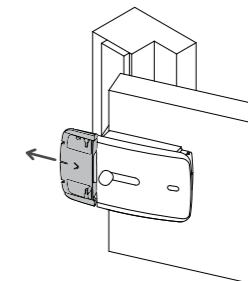

13 Drill the two (or four) marks. Reattach the receiver and with screws 01 and 02.

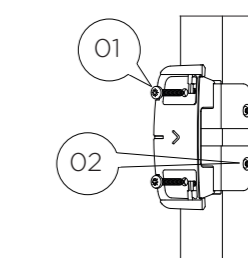

16 Once the product is installed, scan the QR code and follow the steps indicated by the APP.

RECOMMENDATIONS

- ✓ Before leaving home, check that the bolt is working properly.
- ✓ If opening or closing is not completed, contact Watchman Door technical service.
- ✓ In the APP you can check the status of the wBolt battery.